

fig. 20

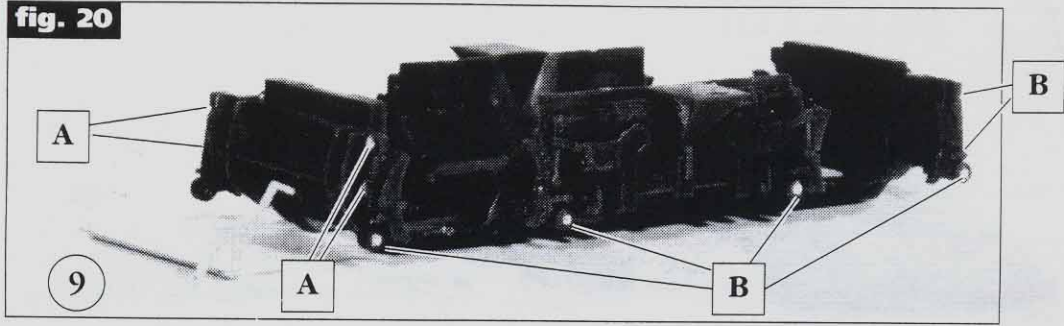

fig. 21

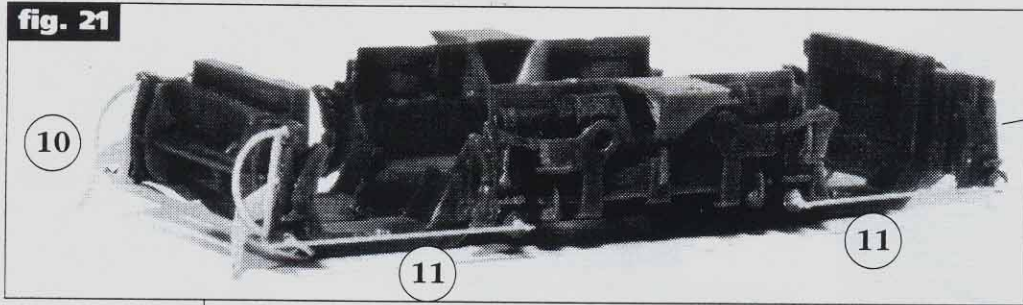

fig. 22



fig. 23

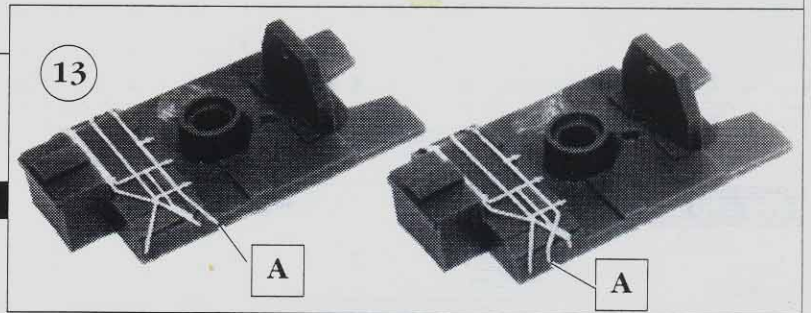

fig. 24

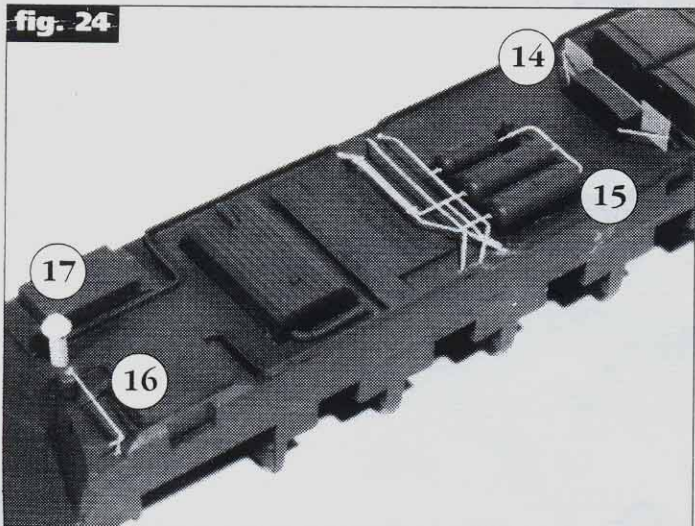

fig. 25

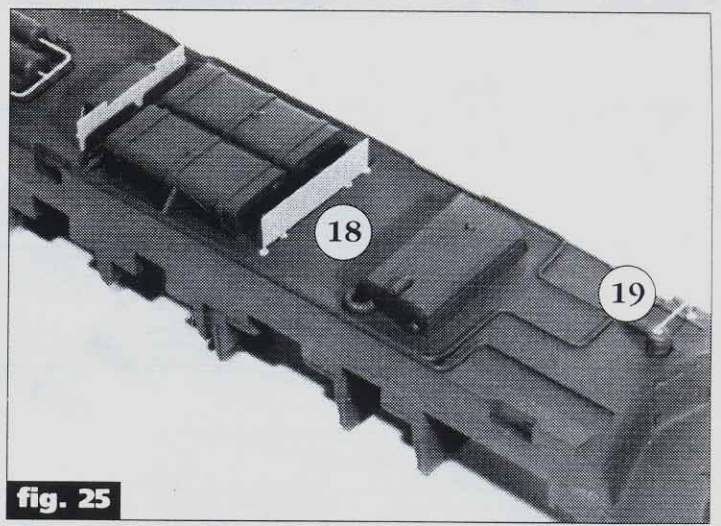

fig. 26

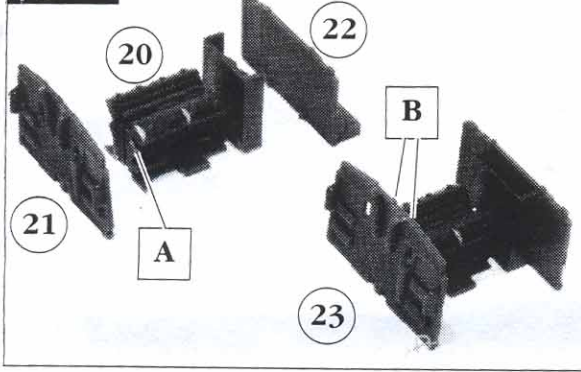

fig. 27

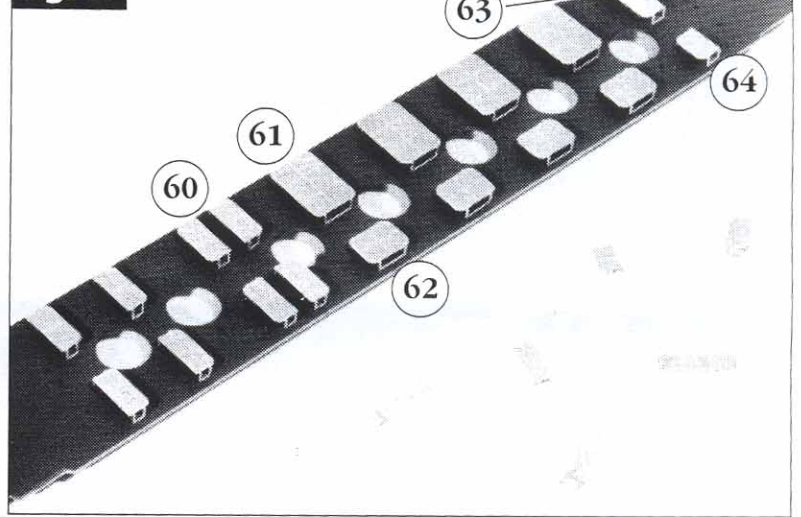

fig. 28

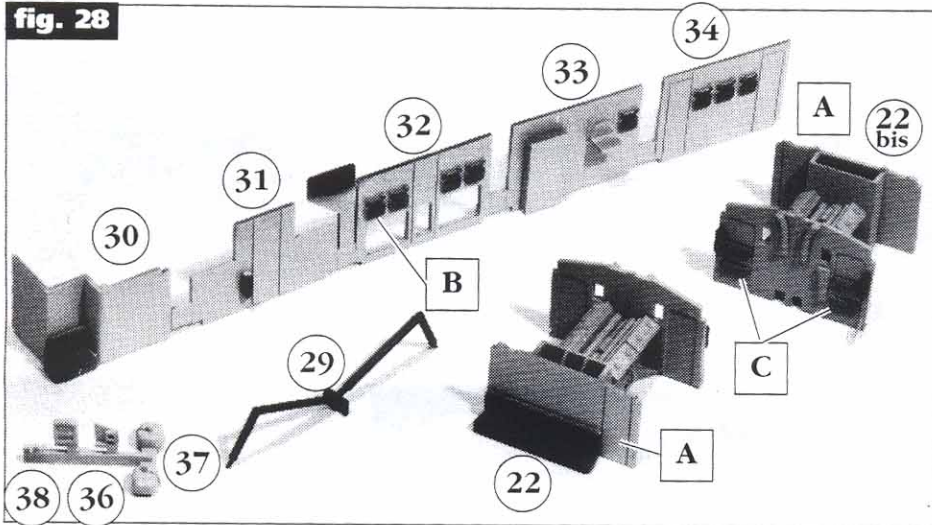

fig. 29

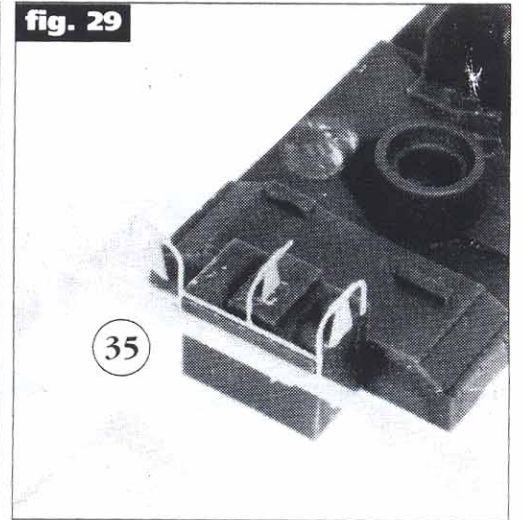

fig. 30

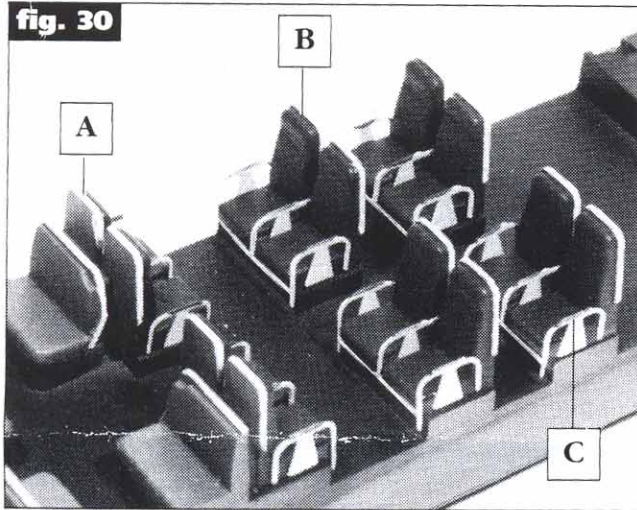

fig. 31

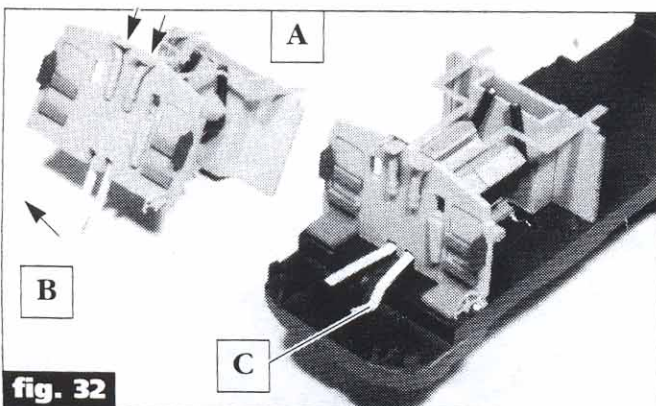
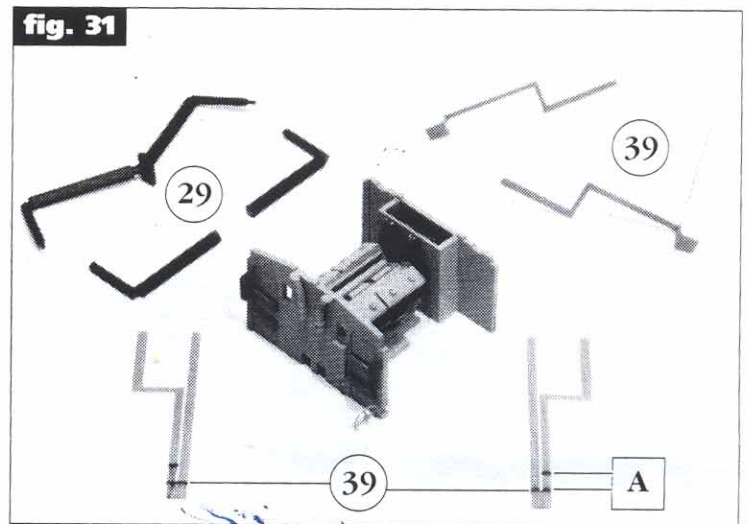

fig. 33

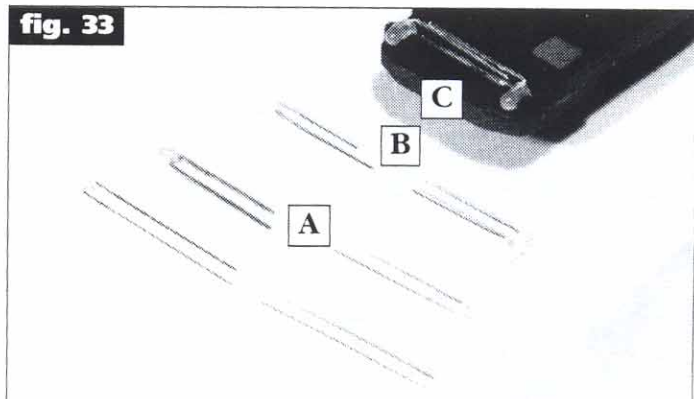

fig. 34

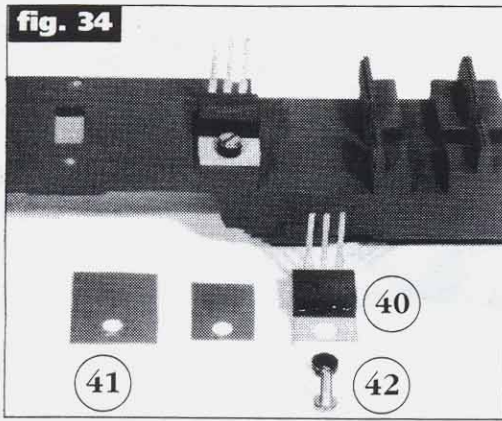

fig. 35

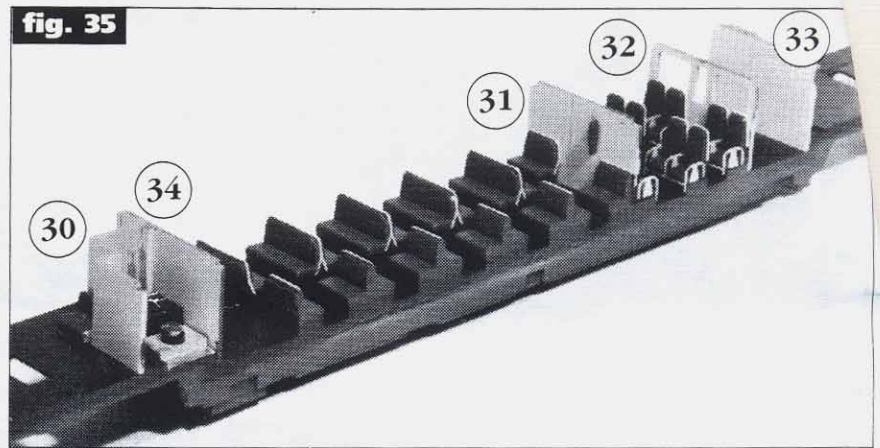

fig. 36

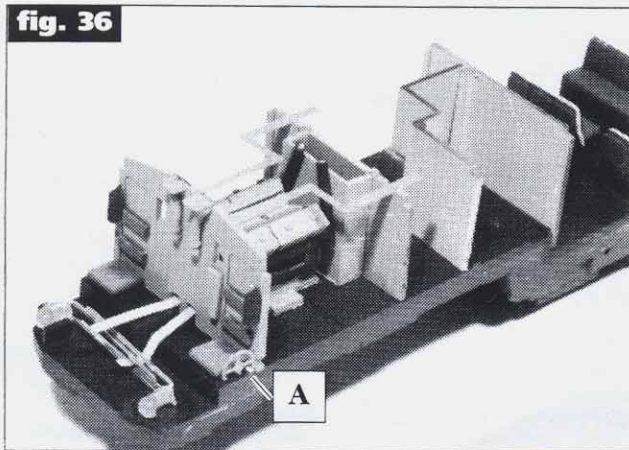

fig. 38

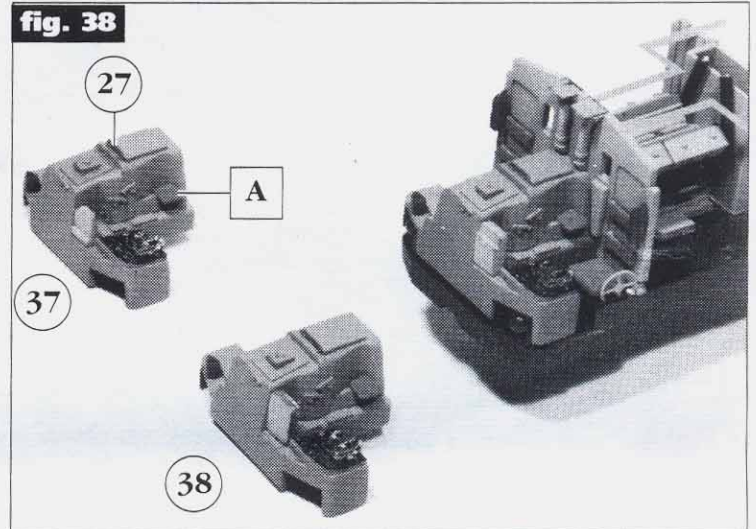

fig. 37

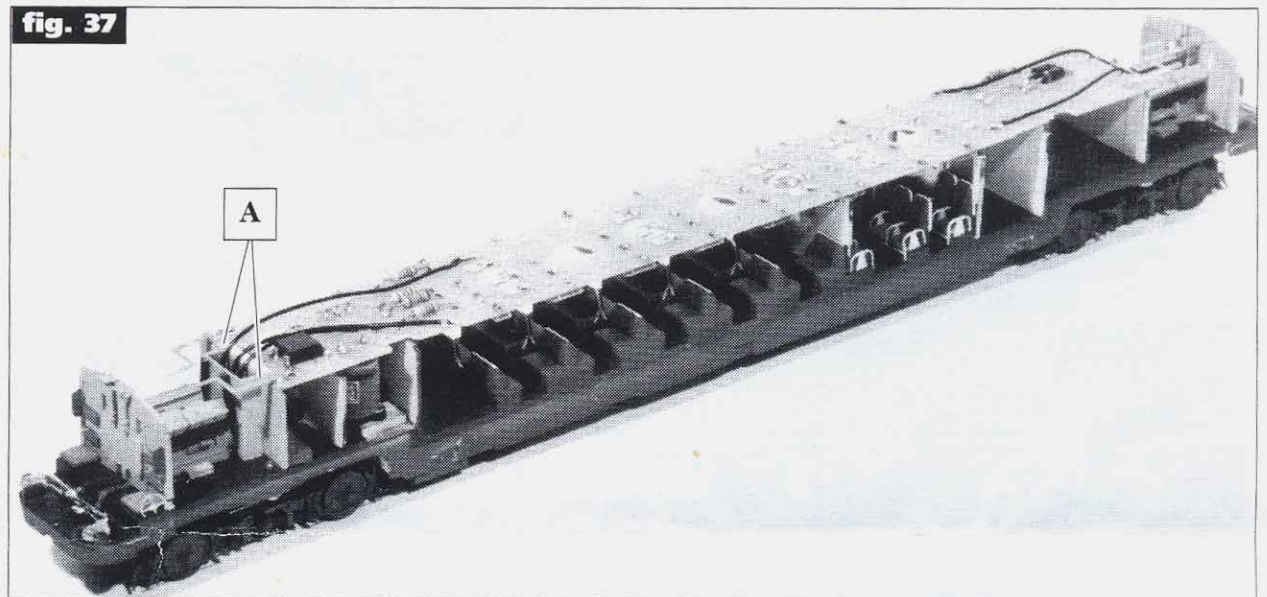

fig. 39

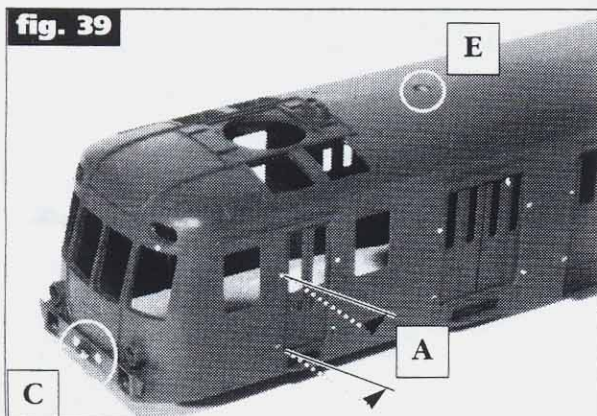

fig. 40

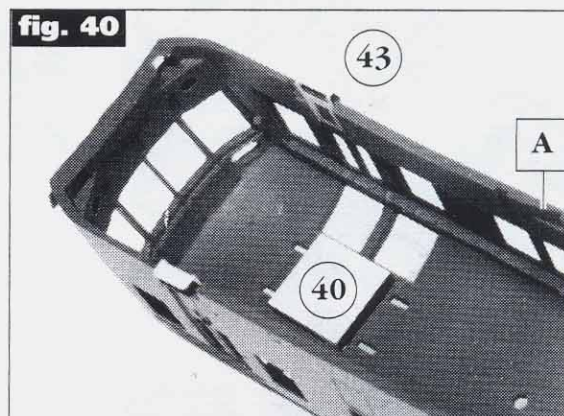

fig. 41



fig. 42

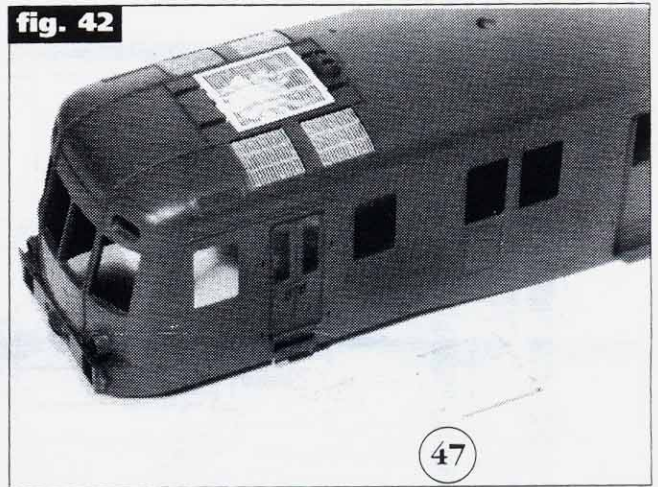

fig. 43

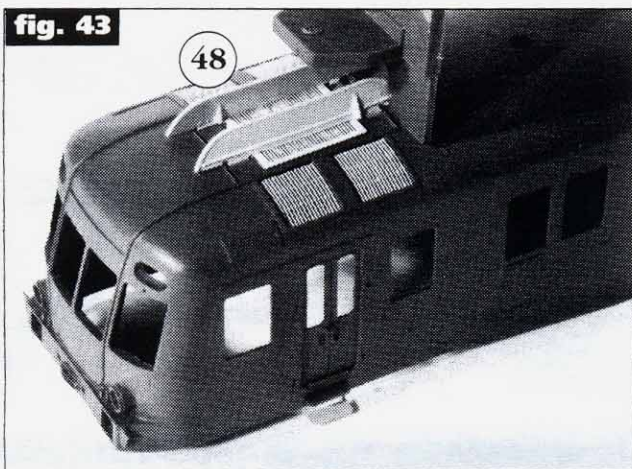

fig. 44

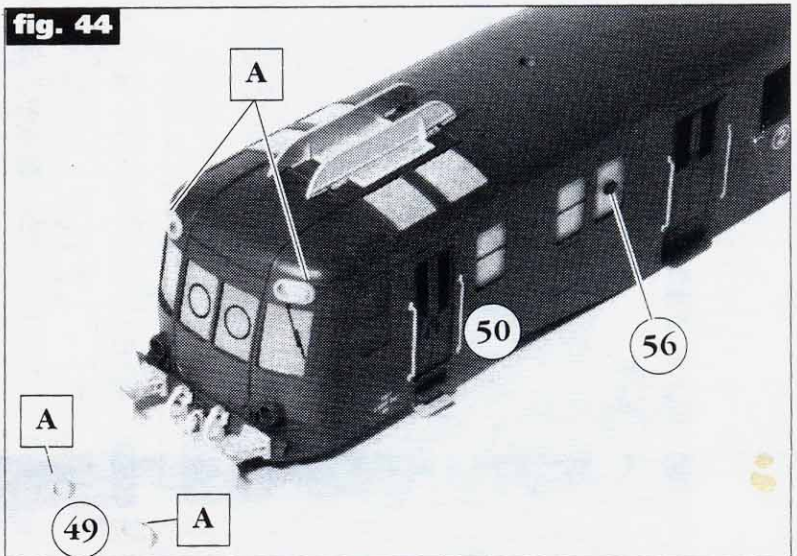

fig. 45

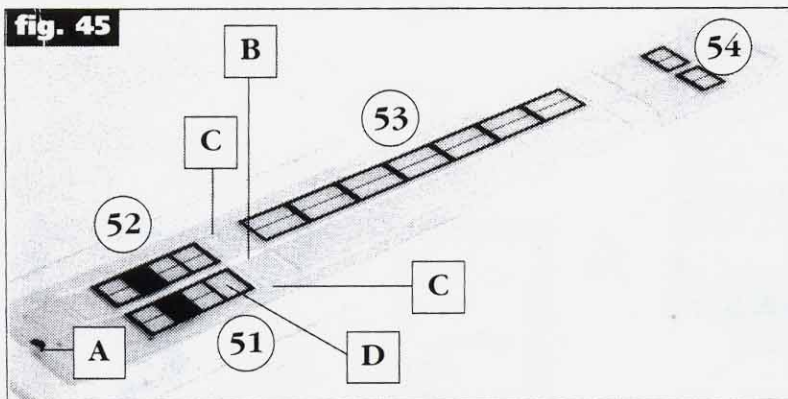
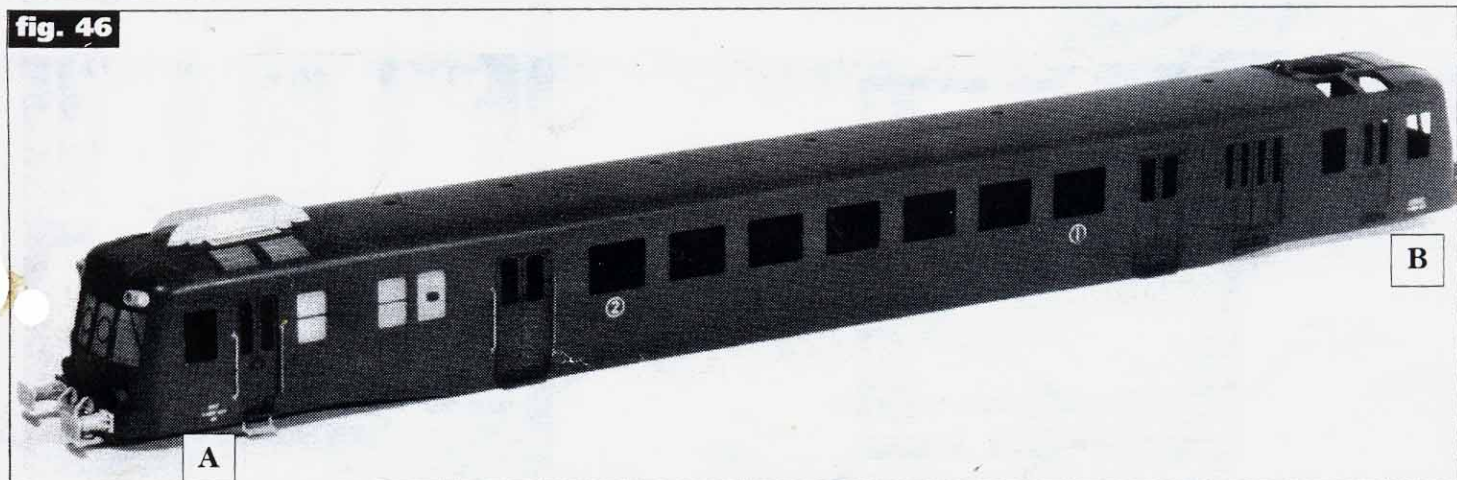
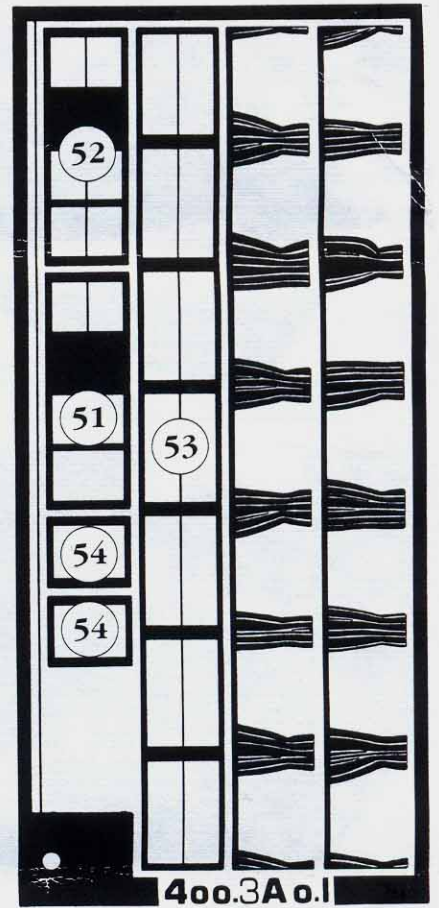
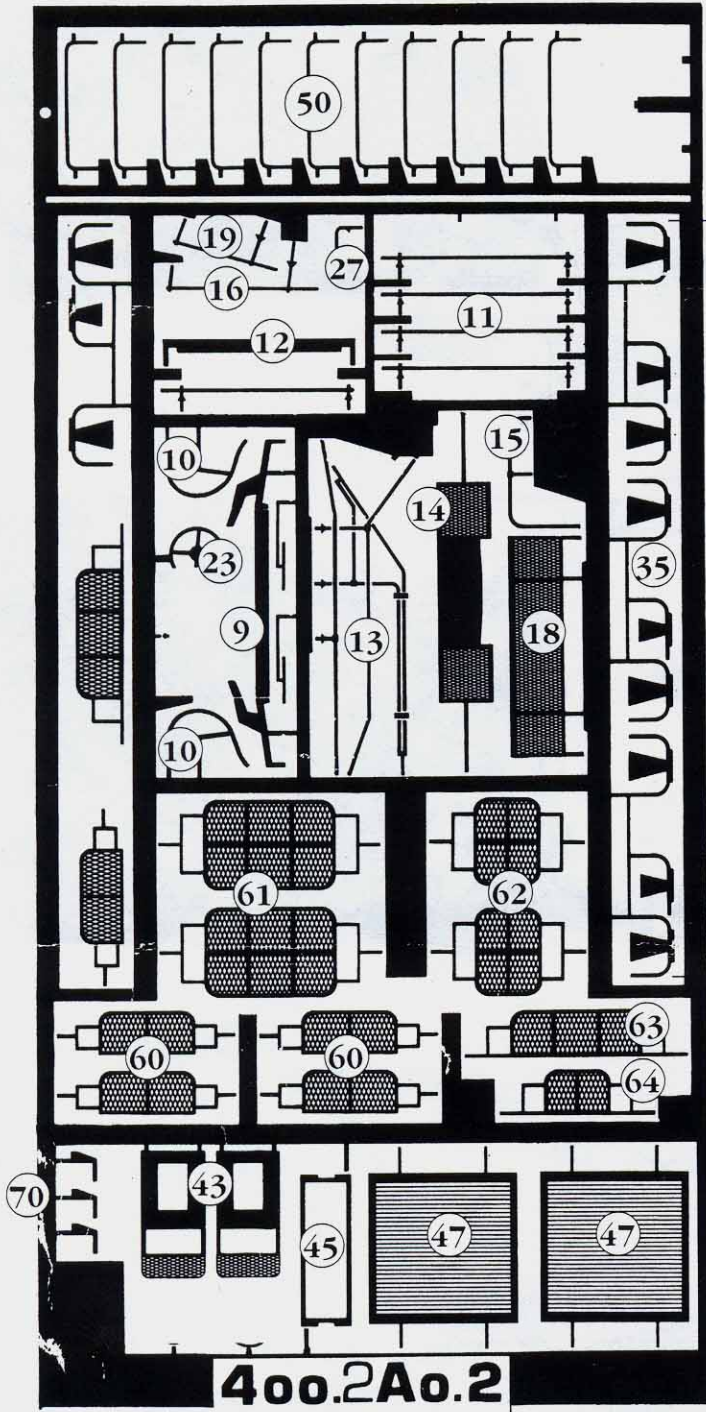

fig. 46





400.3Co.1

